

Dişli Pompa Karakteristikleri / Gear Pump Use Guide

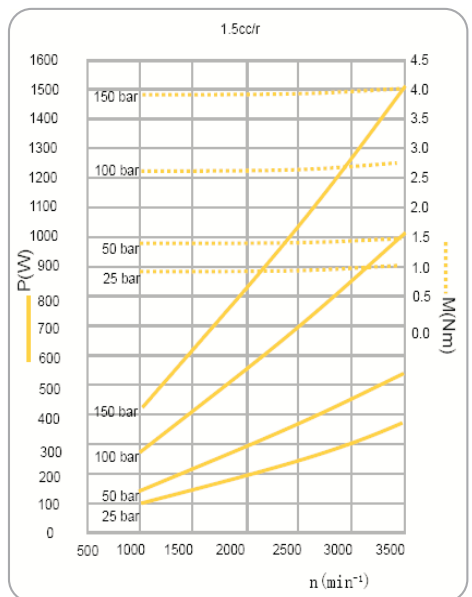

Dişli Pompa Karakteristikleri / Gear Pump Use Guide

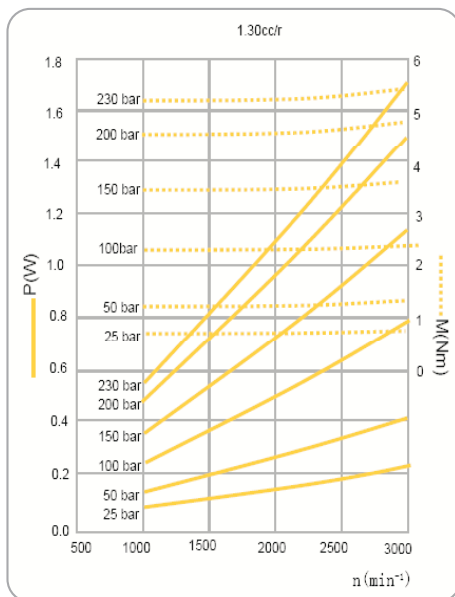
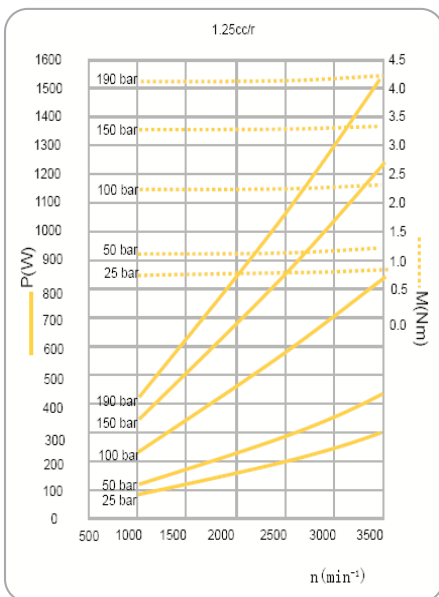
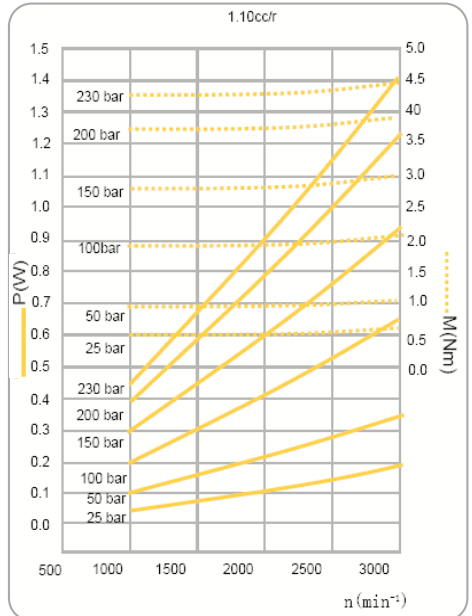
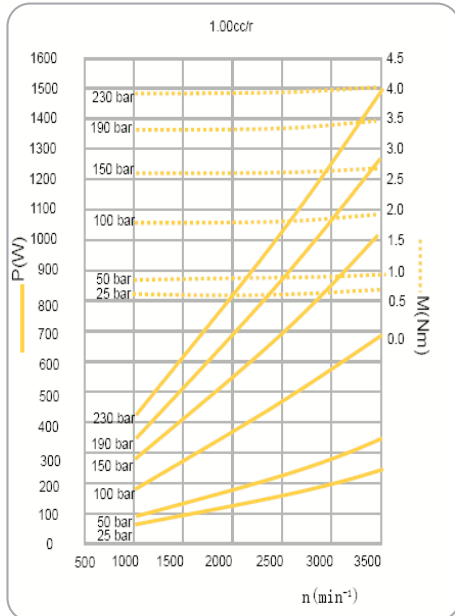
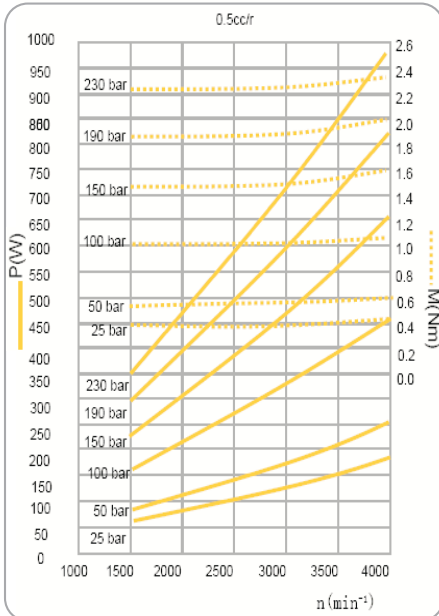
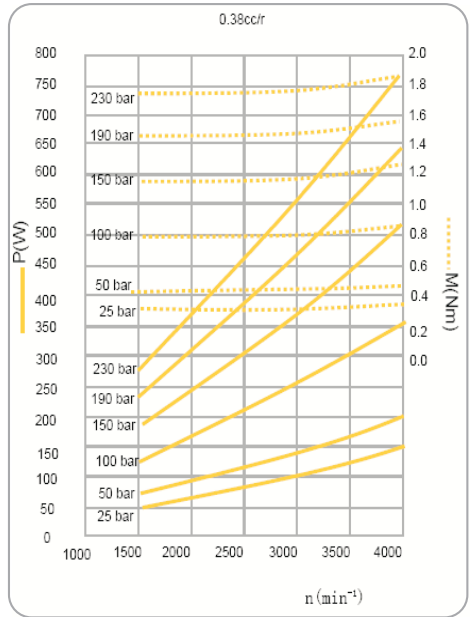
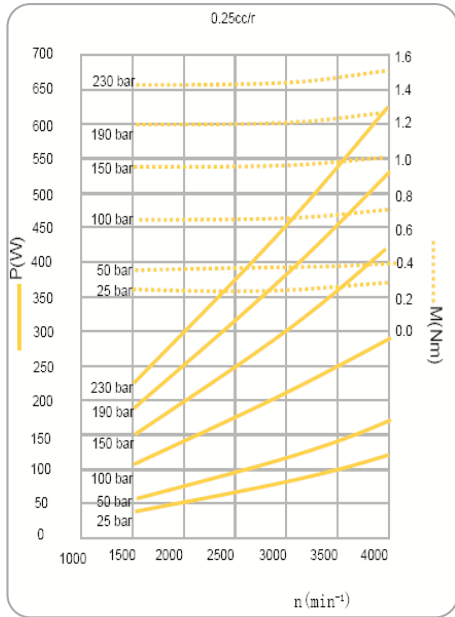
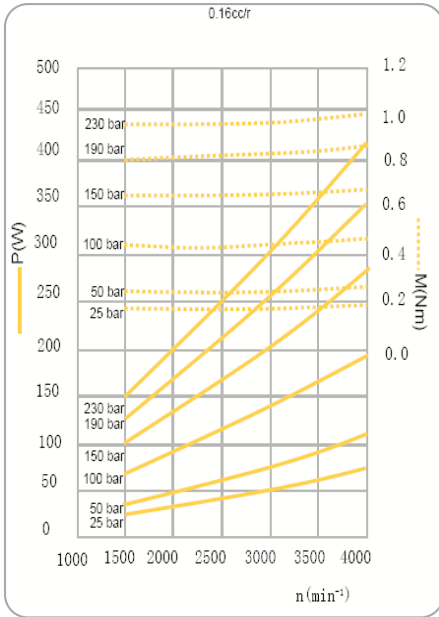
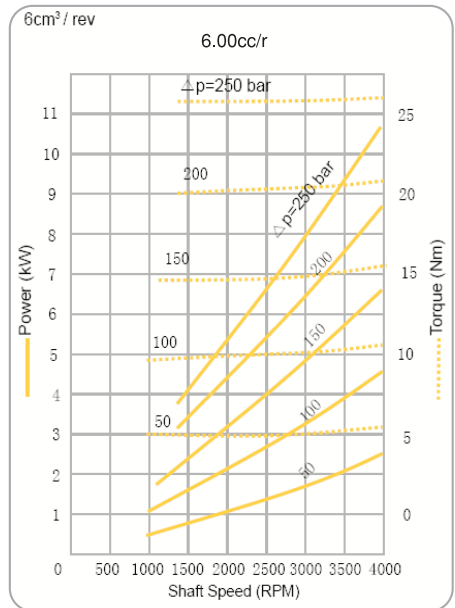
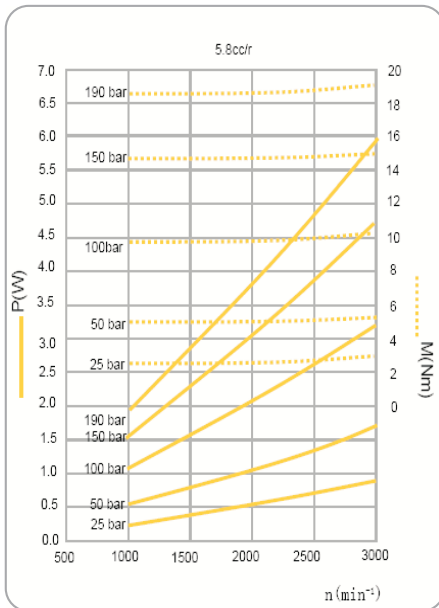
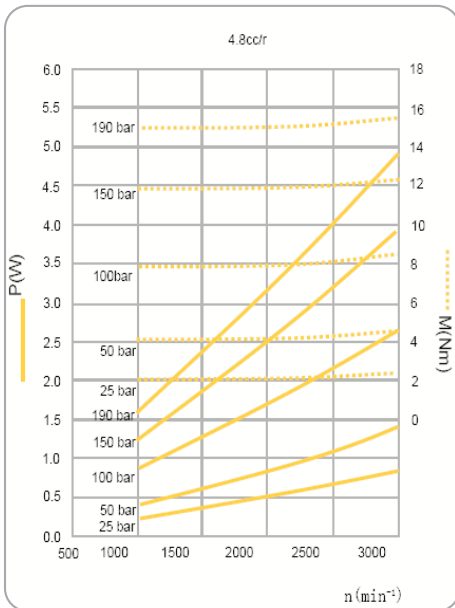
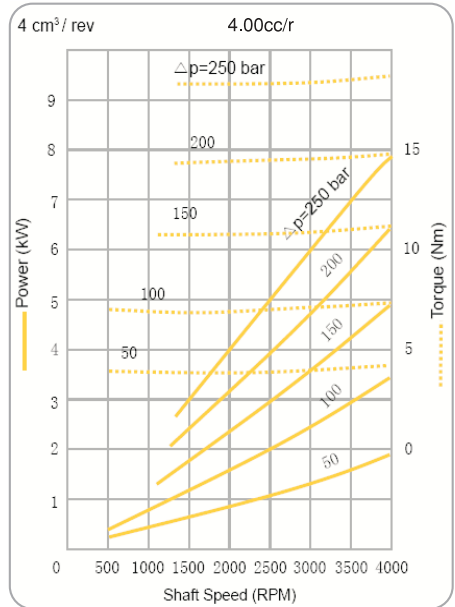
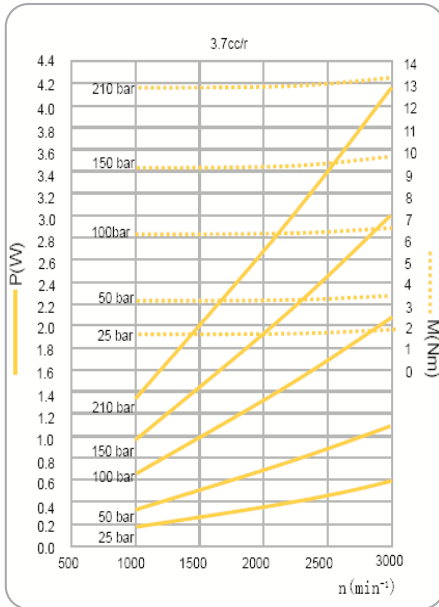
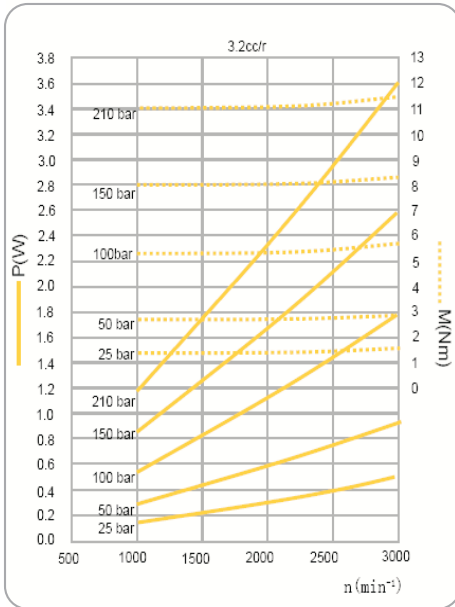
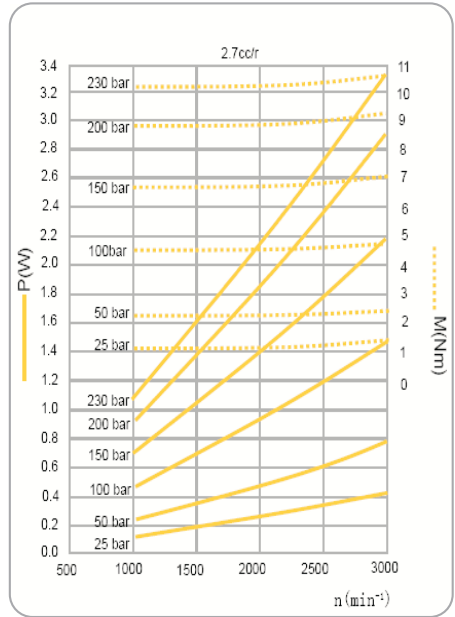
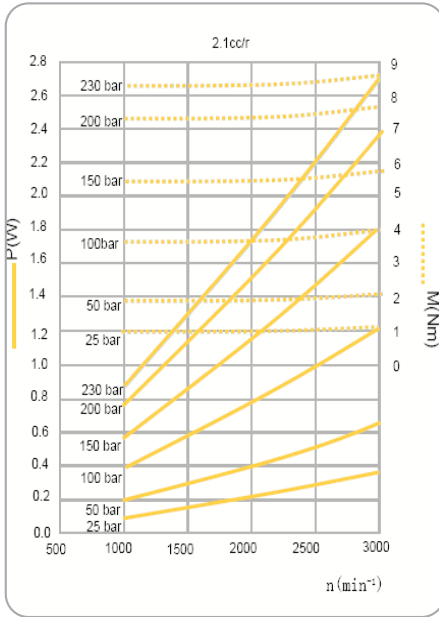
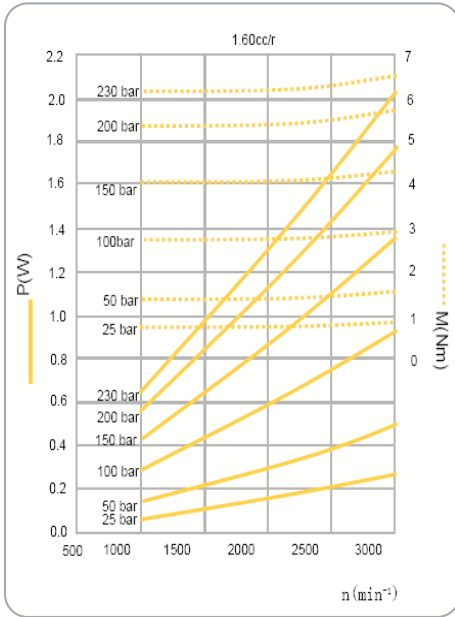

0PFL**B01*****



0 Grup / Group 0

P: Dişli pompa / Gear pump

Pompa deplasmanı / Pump displacement

Emiş / basınç pozisyonu / Inlet / outlet combination

0

P

F

L07

B01

BF

F: Basınç seviyesi / Pressure level: 200 bar

G: Basınç seviyesi / Pressure level: 250 bar

Şaft ve flanş pozisyonu / Shaft extension and flange combination

Dönüş yönü / Rotation direction:

L: sol / CCW

R: sağ / CW

Emiş / basma hattı pozisyonu / Inlet / out position combination:
BF- emiş arka kapak ve basınç ön kapak / back inlet and front out.

OPFL**B01*****

MODEL	DISP. DISPLACEMENT (ml/r)	BASINÇ/PRESSUR (bar)		DEVİR / SPEED (r/min)			L (mm)	EMİŞ / INLET
		RATED	PIK / PEAK	RATED	MAX	Min		
OPF0.16L07B01***	0.16	200	250	2000	6000	800	61	G1/4
OPF0.25L07B01***	0.25	200	250	2000	6000	800	62	
OPF0.38L07B01***	0.38	200	250	2000	6000	800	62.5	
OPF0.50L07B01***	0.50	200	250	2000	6000	800	63	
OPF0.75L07B01***	0.75	200	250	2000	6000	800	66	
OPF1.00L07B01***	1.00	200	250	2000	6000	800	68	
OPF1.25L07B01***	1.25	200	250	2000	5000	800	71	
OPF1.50L07B01***	1.50	200	250	2000	4500	800	73	
OPF1.75L07B01***	1.75	200	250	2000	4000	800	75	
OPF2.00L07B01***	2.00	160	200	2000	3500	800	77	

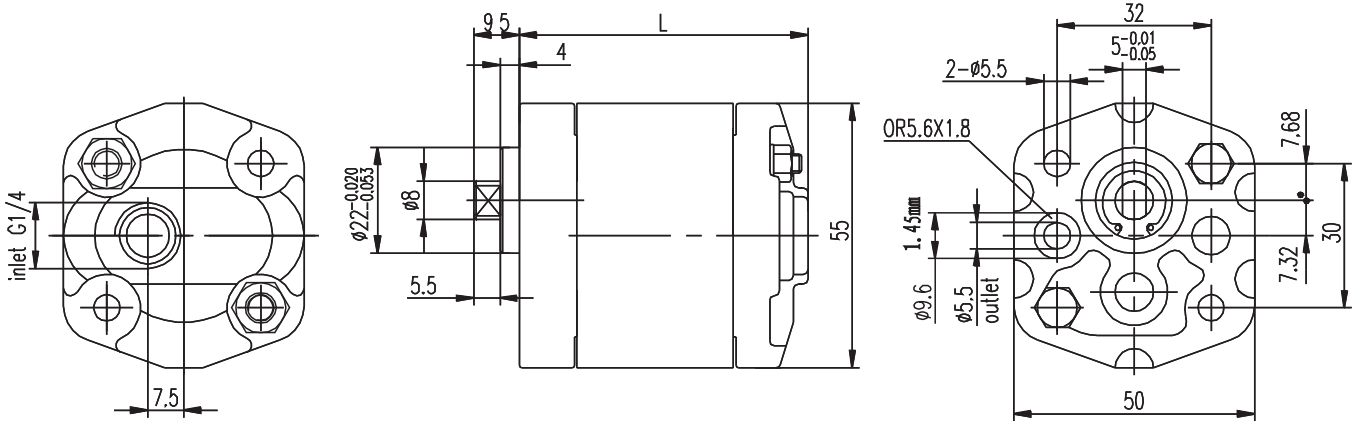
OPFL07B01LBF**

1PF*L**B02*****

1 Grup / Group 1



P: Dişli pompa / Gear pump

F: Basınç seviyesi / Pressure level: 200 bar

G: Basınç seviyesi / Pressure level: 250 bar

Pompa deplasmanı / Pump displacement

Emiş / basınç pozisyonu / Inlet / outlet combination

1

P

F

L**

B02

L

BF

Şaft ve flanş pozisyonu / Shaft extension and flange combination

Dönüş yönü / Rotation direction:
L: sol / CCW
R: sağ / CW

Emiş / basma hattı pozisyonu / Inlet / out position combination:
BF- emiş arka kapak ve basınç ön kapak / back inlet and front out.



1PF*L**B02*****

MODEL	DiSP. DISPLACEMENT (ml/r)	BASINÇ/PRESSUR (bar)		DEVİR / SPEED (r/min)			L (mm)	EMİŞ / INLET
		RATED	Pik / PEAK	RATED	MAX	Min		
1PF1.1L01B02***	1.1	200	250	2000	6000	600	74	G3/8
1PF1.3L01B02***	1.3	200	250	2000	6000	600	75	
1PF1.6L01B02***	1.6	200	250	2000	6000	600	76	
1PF1.8L01B02***	1.8	200	250	2000	6000	600	77	
1PF2.1L01B02***	2.1	200	250	2000	6000	600	78	
1PF2.7L01B02***	2.7	200	250	2000	6000	600	80	
1PF3.2L01B02***	3.2	200	250	2000	5000	600	82	
1PF3.7L01B02***	3.7	200	250	2000	4500	600	84	
1PF4.2L01B02***	4.2	200	250	2000	4000	600	86	
1PF4.8L01B02***	4.8	160	200	2000	3500	600	88	
1PF5.8L01B02***	5.8	160	200	2000	2900	600	92	
1PF8.0L01B02***	8.0	160	200	2000	2100	600	100	

